



SOUND SOLUTIONS



8Ω HiFi PREMIUM KEVLAR CEILING SPEAKER WITH MAGNETIC GRILLE

Tweeter Attenuator

Ultra Low Profile Micro-Flange Magnetic Grille

Premium audio Kevlar woofer with suspended coaxial neodymium magnet titanium tweeter

High Quality Cross-Over Network UL-8540T Protective back

BLACK GRILLE
Replacement ultra low profile grille available in black. Grille Only. Sold separately. See Page: 7

SOLD IN PAIRS

SERIES MODELS

New super-slim grille with ultra low profile flange of only 5mm. Contemporary design. Multiple magnets hold the metal grille securely. Built from strong rigid plastics that are fire retardant to UL-8540T. Quick-install clamp system for 25mm to 5mm thickness. Long-life driver design with sealed motor system, butyl rubber surround and an advanced woven kevlar yellow cone. Premium audio sound optimised with a 12dB crossover and a front fascia selectable tweeter attenuator. 20mm Titanium dome tweeter with silk surround and phase cap provides very natural sounding high end audio. Gold plated spring terminals for larger bare wire or 4mm banana plug connection to any 8 ohm HiFi audio amplifier. Sold Packaged in Stereo pairs.

6½" ADS65-100MG



Optional Replacement Black Grille. Part No: ICGR-6B

Code	ADS65-100MG
Size	6.5"
Input	8Ω
Freq.	55Hz-20kHz
Impedance	8Ω
Pmax	100W
Prms	50W
Sens.	88dB
Packaging	Pair

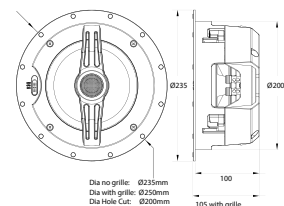

8" ADS8-160MG



Optional Replacement Black Grille. Part No: ICGR-8B

Code	ADS8-160MG
Size	8"
Input	8Ω
Freq.	50Hz-20kHz
Impedance	8Ω
Pmax	160W
Prms	80W
Sens.	89dB
Packaging	Pair

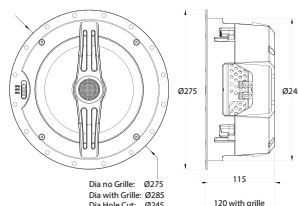

ACCENTO-DYNAMICA KEVLAR CEILING SPEAKER WITH BLUETOOTH

Premium audio Kevlar woofer with suspended coaxial neodymium magnet titanium tweeter

Bluetooth

Ultra Low Profile Micro-Flange Magnetic Grille

Tweeter Attenuator

BLACK GRILLE
Replacement ultra low profile grille available in black. Grille Only. Sold separately.

MASTER/SLAVE SPEAKER PAIR
This speaker set includes an active and a passive speaker. The amplified speaker includes connections for power and optional RCA line input. Connects to the 2nd speaker with common speaker wire.

SOLD IN PAIRS

Accento Dynamica's Amplified ceiling speaker kit consists of two in-ceiling speakers. One with a built-in stereo amplifier and another passive speaker connected by common speaker cable (Not included). This kit features a Bluetooth® receiver for effortlessly streaming music wirelessly from a smartphone, tablet, laptop or computer. It has a super-slim grille with an ultra low profile flange of only 5mm. Multiple magnets hold the metal grille securely. The active speaker has power connectors, RCA line input to directly connect to a second audio source and gold plated spring terminals output to connect to the passive speaker. The speaker will automatically switch to the RCA line input source if the Bluetooth is inactive. Long-life driver design with sealed motor system, butyl rubber surround and an advanced woven kevlar yellow cone. Premium audio sound optimised with a 12dB crossover and a front fascia selectable tweeter attenuator. 20mm Titanium dome tweeter with silk surround and phase cap provides very natural sounding high end audio. Sold as a pair and includes power adaptor.

6½" ADS65-60BT



Optional Replacement Black Grille. Part No: ICGR-6B

Code	ADS65-60BT
Size	6.5"
Speaker	Active
Bluetooth	V4.1+EDR
Freq.	55Hz-20kHz
Pmax	60W x2
Prms	30Wrms per channel
Sens.	88dB
Packaging	Pair

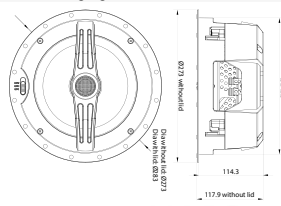

8" ADS8-100BT



Optional Replacement Black Grille. Part No: ICGR-8B

Code	ADS8-100BT
Size	8"
Speaker	Active
Bluetooth	V4.1+EDR
Freq.	50Hz-20kHz
Pmax	100W x2
Prms	50Wrms per channel
Sens.	89dB
Packaging	Pair

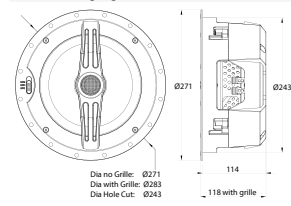

8Ω HiFi PREMIUM AMT CEILING SPEAKER WITH MAGNETIC GRILLE

MICRO-FLANGE

Modern low profile flange design that's unobtrusive and slim line that will suit traditional and modern decor's seamlessly.

AMT TWEETER SYSTEM

Air Motion Transformers (AMT) are high frequency electrostatic transducers that produce clarity with high transient speed. Unique to Accento-Dynamica, AMT tweeters achieve a level of musicality not normally found in a ceiling speaker system.

HI-END WOOFER CONSTRUCTION

Cone construction is made from black woven kevlar material designed and constructed to be light but rigid for excellently controlled tight bass with live natural sound. Mounted in an anodised metal basket with butyl rubber surround for long exertion high SPL efficiency, low resonance and long life durability. Premium audio quality.

CROSS-OVER NETWORK

Engineered using high quality components designed to perfectly match the tweeter and woofer for exceptional sound reproduction. 12dB/Octave with ATM Tweeter level attenuation adjustment.



SERIES MODELS

New super-slim grille with ultra low profile flange of only 5mm. Contemporary design. Multiple magnets hold the metal grille securely. Built from strong rigid plastics that are fire retardant to UL-8540T. Quick-install clamp system for 40mm to 10mm thickness. The performance oriented design includes a woofer constructed with high exertion butyl rubber surround and an advanced, stiffened, woven kevlar cone material for quality, strength and long-life durability. Premium audio sound is optimised with a 12dB crossover and a front fascia selectable tweeter attenuator. Air Motion Transformers (AMT) are high frequency electrostatic transducers that produce clarity with high transient speed. Gold plated spring terminals for larger bare wire or 4mm plug connection to any 8 ohm HiFi audio amplifier. Sold packaged in stereo pairs.

6½" ADS65AMT-120MG



Optional Replacement
Black Grille, Part No: MIGR-6B

Code	ADS65AMT-120MG
Size	6.5"
Input	8Ω
Freq.	56Hz-20kHz
Impedance	8Ω
Pmax	120W
Prms	60W
Sens.	89dB
Packaging	Pair

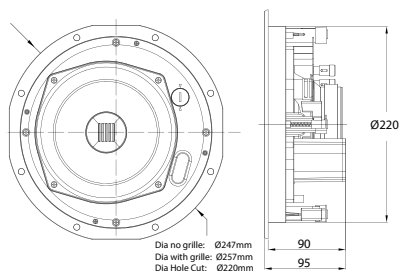

8" ADS8AMT-160MG



Optional Replacement
Black Grille, Part No: MIGR-8B

Code	ADS8AMT-160MG
Size	8"
Input	8Ω
Freq.	48Hz-20kHz
Impedance	8Ω
Pmax	160W
Prms	80W
Sens.	90dB
Packaging	Pair

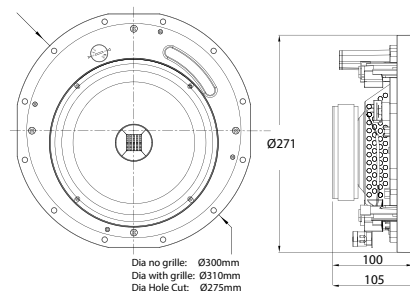

8Ω HiFi MICA-PP CEILING SPEAKER WITH MAGNETIC GRILLE

MICRO-FLANGE

Modern low profile 5mm flange design that's unobtrusive and slim line that will suit traditional and modern decor's seamlessly.

SUSPENDED TWEETER SYSTEM

Suspended 20mm Titanium dome tweeter with silk surround, above mounted in coaxial configuration for excellent HiFi audio sound. Selectable tweeter attenuation adjustment.

HI-END WOOFER CONSTRUCTION

Cone construction is made from blue Mica-Polypropylene material designed and constructed to be light but rigid for excellently controlled tight bass with live natural sound. Butyl rubber surround for long exertion high SPL efficiency, low resonance and long life durability.

CROSS-OVER NETWORK

Engineered using high quality components designed to perfectly match the tweeter and woofer for exceptional sound reproduction. 12dB/Octave with adjustable 0dB / 3dB / 6dB Tweeter level adjustment.

BLACK GRILLE

Replacement ultra low profile grille available in black. Grille Only. Sold separately. See Page: 7



Ultra Low Profile Micro Frame Magnetic Grille

High Quality Components Cross-Over Network 8 Ohm HiFi Input

Tweeter Attenuator

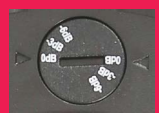

Magnet Grille Fastening

SOLD IN PAIRS

SERIES MODELS

New super-slim grille with ultra low profile flange of only 5mm. Contemporary design. Multiple magnets hold the metal grille securely. Built from strong rigid plastics that are fire retardant to UL-8540T. Quick-install clamp system for 40mm to 10mm panel thickness. Long-life driver design with sealed motor system, butyl rubber surround and mica reinforced polypropylene composite cone. Premium audio sound optimised with a 12dB crossover and a front facia selectable tweeter attenuator. 20mm Titanium dome tweeter with silk surround, above-mounted in coaxial configuration for excellent HiFi audio sound. Spring terminals for conventional bare-wire connection to a majority of common 8 ohm HiFi audio amplifiers. Supplied packaged in pairs for typical stereo installations

4" ADS4-60MG



Optional Replacement Black Grille. Part No: MIGR-4B

Code	ADS4-60MG
Size	4"
Input	8Ω
Freq.	95Hz-20kHz
Impedance	8Ω
Pmax	60W
Prms	30W
Sens.	85dB
Packaging	Pair

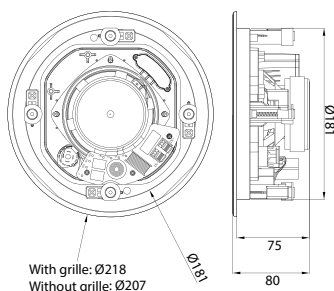

6½" ADS65-80MG



Optional Replacement Black Grille. Part No: MIGR-6B

Code	ADS65-80MG
Size	6.5"
Input	8Ω
Freq.	60Hz-20kHz
Impedance	8Ω
Pmax	80W
Prms	40W
Sens.	87dB
Packaging	Pair

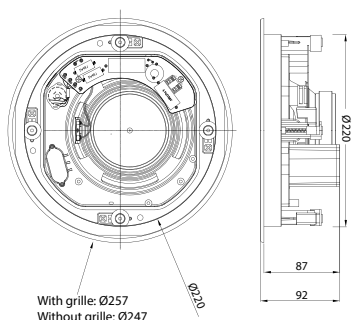

8" ADS8-120MG



Optional Replacement Black Grille. Part No: MIGR-8B

Code	ADS8-120MG
Size	8"
Input	8Ω
Freq.	50Hz-20kHz
Impedance	8Ω
Pmax	120W
Prms	60W
Sens.	88dB
Packaging	Pair

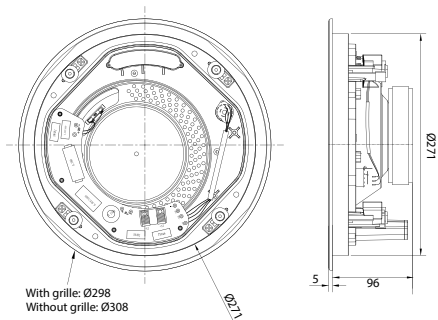

ACCENTO DYNAMICA 100V TYPE CEILING SPEAKER LOW-PROFILE

8 OHM HI-FI / 100V INPUT

Flexible Installation options can installed into 8 Ohm Hi-Fi or 100V PA installations. 8 Ohm high end cross-over network design and multiple 100V Watt Tap Selections.

2-WAY COAXIAL SYSTEM

Suspended 20mm Titanium dome tweeter with silk surround above mounted in coaxial configuration for excellent HiFi audio sound. Tweeter level adjustment.

SUPER SLIM GRILLE

Magnetically held speaker creates a ultra low profile 5mm and virtually frameless appearance as well making installation faster.

BLACK GRILLE

Replacement ultra low profile grille available in black. Grille Only. Sold separately. See Page: 7

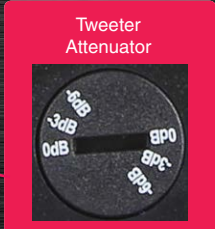

SOLD IN SINGLES

SERIES MODELS

New super-slim grille with ultra low profile flange of only 5mm. Multiple magnets hold the metal grille securely. Easy to install. Built from strong rigid plastics that are fire retardant to UL-8540T. Quick-install clamp system for 40 to 10mm panel thickness. Long-life driver design with sealed motor system, butyl rubber surround and mica reinforced polypropylene composite cone. It features a 100V line audio transformer with taps and 8 ohm spring terminals for inputs. Premium audio sound optimised with a 6dB crossover and a front facia selectable tweeter attenuator. 20mm Titanium dome tweeter with silk surround above mounted in coaxial configuration for excellent HiFi audio sound. Sold packaged in singles. Black grilles are available as an optional extra.

4" ADS4-60MG-T20

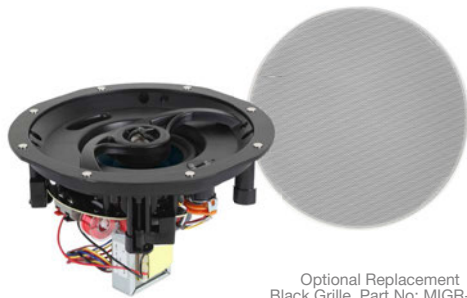

Optional Replacement Black Grille. Part No: MIGR-4B

Code	ADS4-60MG-T20	ADS65-80MG-T40
Size	4"	6.5"
Input	100V	100V
Taps	2.5W / 5W / 10W / 20W	5W / 10W / 20W / 40W
Freq.	96Hz-20kHz	61Hz-20kHz
Pmax	40W	80W
Prms	20W	40W
Sens.	85dB	87dB
Packaging	Single	Single

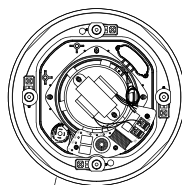

With grille: Ø218
Without grille: Ø207
Hole Cut: Ø185

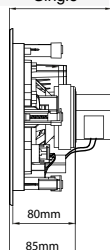

6.5" ADS65-80MG-T40

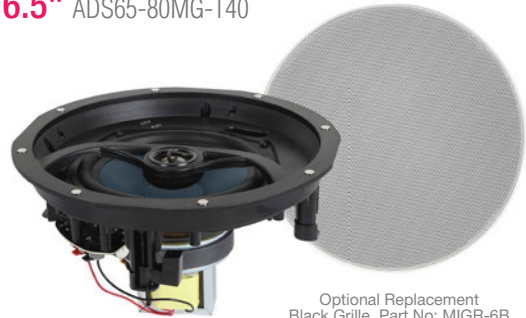

Optional Replacement Black Grille. Part No: MIGR-6B

Code	ADS65-80MG-T40
Size	6.5"
Input	100V
Taps	5W / 10W / 20W / 40W
Freq.	61Hz-20kHz
Pmax	80W
Prms	40W
Sens.	87dB
Packaging	Single

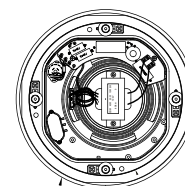

With grille: Ø257mm
Without grille: Ø247mm
Hole Cut: Ø220mm

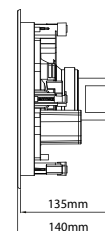

ACCENTO DYNAMICA 8Ω / 100V TYPE CEILING SPEAKER LOW-PROFILE - SEALED BACK

100V INPUT

Designed for commercial 100V PA installations.

FULLY ENCASED

Improved sound with and safety with the metal backcover. Designed with fire retardant materials.

2-WAY COAXIAL SYSTEM

Suspended 20mm Titanium dome tweeter with silk surround above mounted in coaxial configuration for excellent HiFi audio sound. Selectable tweeter adjustment.

SUPER SLIM GRILLE

Magnetically held speaker creates a ultra low profile and virtually frameless appearance as well making installation faster.

BLACK GRILLE

Replacement ultra low profile grille available in black. Grille Only. Sold separately. See Page: 7



Ultra Low Profile Micro Frame

Easy Tap Selection



Magnet Grille Fastening

SOLD IN SINGLES

SERIES MODELS

New super-slim grille with ultra low profile flange of only 5mm. Multiple magnets hold the metal grille securely. Easy to install. This model has an extruded metal back-cover that is fire retardant and gives added ingress protection. Ideal for ceilings where acoustic isolation is required and also improves the speakers sound. Quick-install clamp system for 40mm to 10mm ceiling panel thickness. Long-life driver design with sealed motor system, butyl rubber surround and a mica reinforced polypropylene composite cone. Extended performance with a 20mm Titanium dome tweeter with silk surround, above mounted in coaxial configuration. Includes a 12dB matching crossover. There is an easy-access rotary-switch on the front panel for selecting the 100V Taps or 8 Ohm type input. Sold packaged as singles.

4" ADS4-60MG-CT10

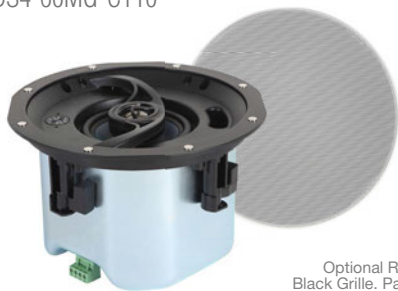

Optional Replacement Black Grille. Part No: MIGR-4B

Code	ADS4-60MG-CT10
Size	4"
Input	8Ω / 100V
Switch	8Ω / 1.25W / 2.5W / 5W / 10W
Freq.	96Hz-20kHz
Pmax	60W
Prms	30W
Sens.	85dB
Packaging	Single

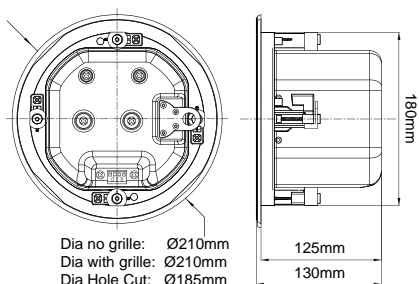

6.5" ADS65-80MG-CT40



Optional Replacement Black Grille. Part No: MIGR-6B

Code	ADS65-80MG-CT40
Size	6.5"
Input	8Ω / 100V
Switch	8Ω / 5W / 10W / 20W / 40W
Freq.	61Hz-20kHz
Pmax	80W
Prms	40W
Sens.	87dB
Packaging	Single

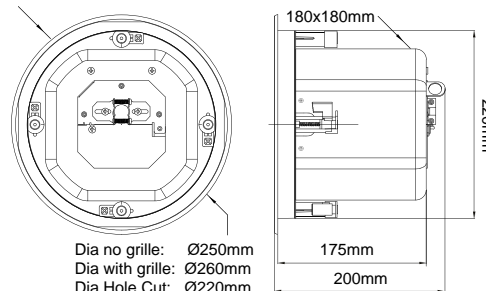

IN-CEILING SPEAKER MOUNTING BRACKET

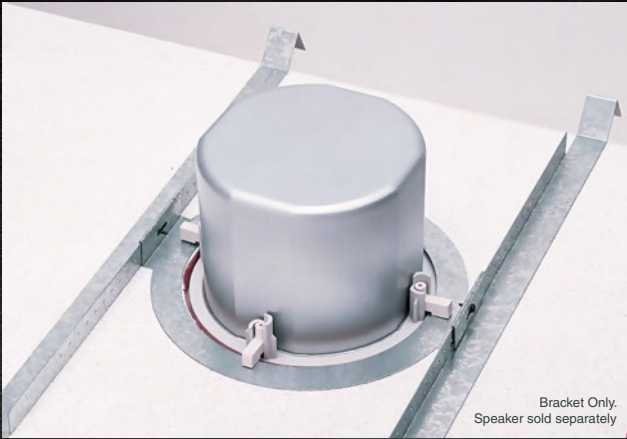

Bracket Only.
Speaker sold separately

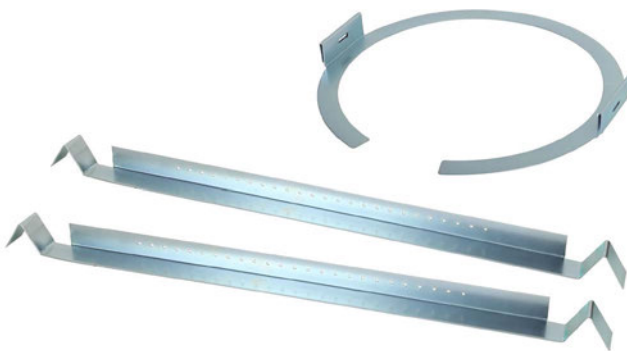
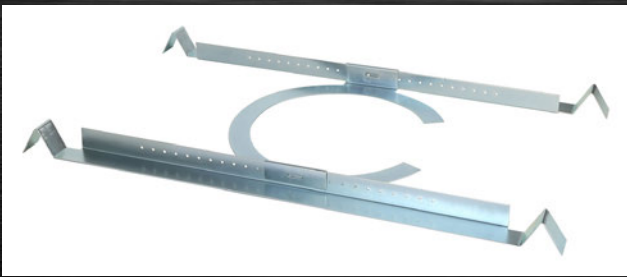

This bracket is designed for an easy and cost-effective way of installing in-ceiling speakers. They are suitable for installing on drywall or drop ceiling. The kits include two bridge brackets which spans the width of the ceiling tile and puts the weight of the speaker on the ceiling frame instead of the tile itself. It also includes a speaker ring that can be secured to the brackets. Ring size is internal diameter (Hole).

Code	CLBKT-4	CLBKT-6	CLBKT-8
Suits	4"	6"	8"
Ring Size	180mmØ	220mmØ	270mmØ

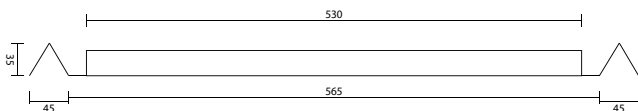

BLACK SPEAKER GRILLES MAGNETIC MOUNT



Black Grilles to suit modern interiors. Easily changeable.

Grille Only.
Speaker sold separately



These metal speaker grilles are tailored to suit Accento Dynamica range of speakers that use a magnetic speaker grille cover. Easy to install. And the magnet on your speakers will hold the grille tightly. Sold in single units. 2 required for pairs.

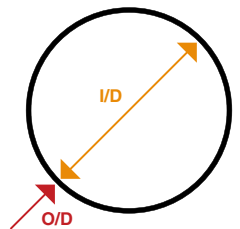

Code	MIGR-4B	MIGR-6B	MIGR-8B	ICGR-6B	ICGR-8B
Colour	Black	Black	Black	Black	Black
I/D	207mm	247mm	298mm	238mm	273mm
O/D	218mm	257mm	308mm	248mm	283mm
Suits	ADS4-60MG, ADS4-60MG-CT10, ADS4-60MG-T20	ADS65-80MG, ADS65AMT-120MG, ADS65-80MG-T40, ADS65-80MG-CT40	ADS8-120MG, ADS8AMT-160MG	ADS65-100MG	ADS8-160MG

8Ω HiFi PREMIUM KEVLAR CEILING SPEAKER

MICRO-FLANGE

Modern low profile flange design that's unobtrusive and slim line that will suit traditional and modern decor's seamlessly.

SUSPENDED TWEETER SYSTEM

High quality 1" Silk dome ferro fluid cooled neodymium magnet tweeter for beautiful sound high end response, mounted independently and suspended from the woofer to ensure the tweeter and woofer work in perfect harmony.

HI-END WOOFER CONSTRUCTION

Cone construction is made from black woven fibre-glass material designed and constructed to be light but rigid for excellently controlled tight bass with live natural sound. Mounted in an anodised metal basket with butyl rubber surround for long exertion high SPL efficiency, low resonance and long life durability.

CROSS-OVER NETWORK

Engineered using high quality components designed to perfectly match the tweeter and woofer for exceptional sound reproduction. 12dB/Octave with adjustable 0dB / 3dB / 6dB Tweeter level adjustment.



SOLD IN PAIRS

SERIES MODELS



BE HEARD
SEND YOUR MESSAGE
LOUD & CLEAR



6 1/2" ADS65M50

MICRO-FLANGED STYLE.

25mm aluminium voice coil. Black fibre-glass cone. Inverted dust cap. Butyl rubber surround. Anodised metal basket. 25mm Silk dome tweeter with Ferro fluid cooled Neodymium magnet. 8Ω Input, 12dB/Octave cross-over. Push Terminals. High Sensitivity 90dB/1W. Easy Swivel clamp mounting.

Code	ADS65M50
Size	6.5"
Freq.	61Hz-20KHz
Input	8Ω
Pmax	100W
Prms	50W
Sens.	89dB
Packaging	Pair

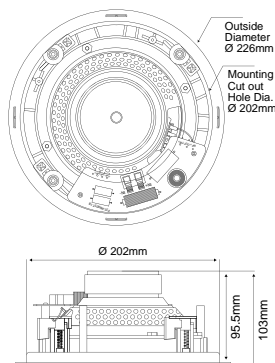

8" ADS8M80

MICRO-FLANGED STYLE.

35mm aluminium voice coil. Black fibre-glass cone. Inverted dust cap. Butyl rubber surround. Anodised metal basket. 25mm Silk dome tweeter with Ferro fluid cooled Neodymium magnet. 8Ω Input, 12dB/Octave cross-over. Push Terminals. High Sensitivity 90dB/1W. Easy Swivel clamp mounting.

Code	ADS8M80
Size	8"
Freq.	40Hz-20KHz
Input	8Ω
Pmax	160W
Prms	80W
Sens.	90dB
Packaging	Pair

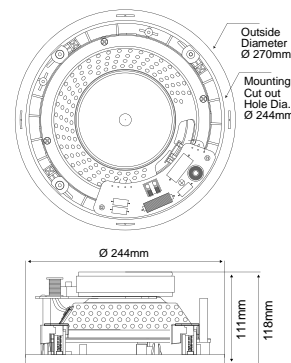

8Ω HiFi PREMIUM KEVLAR CEILING SPEAKER RAPID INSTALL SYSTEM

RAPID INSTALLATION SYSTEM !

Unique Push-To-Release spring loaded auto mounting clamps. Spiral fastener auto-fits ceiling depth 10-25mm. Use the 1/4" Allen Key (Included) for easy half-turn release of the clamp to remove the speaker. Time saving, simple, reliable and no-fuss mounting process.

MICRO-FLANGE

Modern low profile flange design that's unobtrusive and slim line that will suit traditional and modern decor's seamlessly.

TILT COAXIAL TWEETER

High quality 1" Silk dome ferro fluid cooled neodymium magnet tweeter for beautiful sound high end response. Tweeter can be tilted to give directionality to sound and an attenuator switch for softening presence and flawless sound.

HI-END WOOFER CONSTRUCTION

Cone construction is made from woven Kevlar material designed for premium sound quality audio & warm bass. Mounted in an anodised metal basket with butyl rubber surround for long exertion high SPL efficiency, low resonance and long life durability.

CROSS-OVER NETWORK

Engineered using high quality components designed to perfectly match the tweeter and woofer for exceptional sound reproduction. 12dB/Octave with adjustable 0dB / 3dB / 6dB Tweeter level adjustment.



RAPID INSTALL SYSTEM
8 SECOND INSTALLATION.
SEE PAGE 14 FOR DETAILS

SOLD IN PAIRS

SERIES MODELS



6½" ADS65F40

FAST INSTALL

Rapid Push-Release mounting system. 25mm Silk dome tweeter with tilt adjust with high range attenuator switch 12dB/Octave electronic crossover. Yellow woven Kevlar mid-woofer 6½". Long-life Butyl Rubber roll surround. Aluminium high temp' voice coil. Anodised steel frame back grille.

Code	ADS65F40
Size	6.5"
Freq.	55Hz-20KHz
Input	8Ω
Pmax	80W
Prms	40W
Sens.	87dB
Packaging	Pair

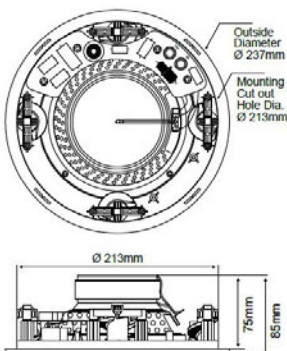

8" ADS8F80

FAST INSTALL

Rapid Push-Release mounting system. 25mm Silk dome tweeter with tilt adjust with high range attenuator switch 12dB/Octave electronic crossover. Yellow woven Kevlar mid-woofer 8". Long-life Butyl Rubber roll surround. Aluminium high temp' voice coil. Anodised steel frame back grille.

Code	ADS8F80
Size	8"
Freq.	53Hz-20KHz
Input	8Ω
Pmax	160W
Prms	80W
Sens.	90dB
Packaging	Pair

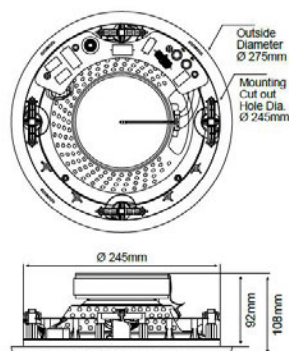

6½" ADS365F40

FAST INSTALL

Rapid Push-Release mounting system. Independent 25mm Silk dome tweeter with tilt adjust with high range attenuator switch 12dB/Octave electronic crossover. Yellow woven Kevlar mid-woofer 6½". Long-life Butyl Rubber roll surround. Aluminium high temp' voice coil. Anodised steel frame back grille.

Code	ADS365F40
Size	6.5"
Freq.	55Hz-20KHz
Input	8Ω
Pmax	80W
Prms	40W
Sens.	87dB
Packaging	Pair

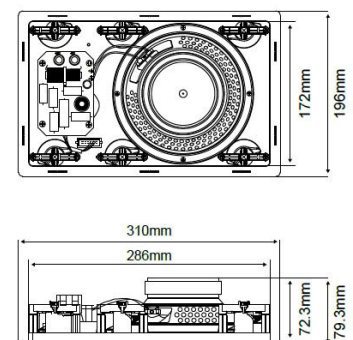

8Ω HiFi PREMIUM KEVLAR CEILING SPEAKER

SAFETY PLASTIC

Constructed from Fire retardant plastics to UL-8540T.

TILT COAXIAL TWEETER

High quality titanium tweeter for beautiful sound and high end response. Tweeter can be tilted to give directionality to sound and an attenuator switch for softening presence and flawless sound.

HI-END WOOFER CONSTRUCTION

Cone construction is made from woven Kevlar material designed for premium sound quality audio & warm bass. Mounted in an anodised metal basket with butyl rubber surround for long exertion high SPL efficiency, low resonance and long life durability.

CROSS-OVER NETWORK

Engineered using high quality components designed to perfectly match the tweeter and woofer for exceptional sound reproduction.



SOLD IN PAIRS

SERIES MODELS



5 1/4" ADS2550

KEVLAR & TITANIUM

High performance Audiophile grade. 2-Way coaxial w/ PTC overdrive protected titanium coated tweeter. Kevlar Mid-Woofer. Spring terminals.

Code	ADS2550
Size	5.25"
Input	8Ω
Pmax	100W
Prms	50W
Freq.	70Hz-20Khz
Sens.	88dB
Packaging	Pair

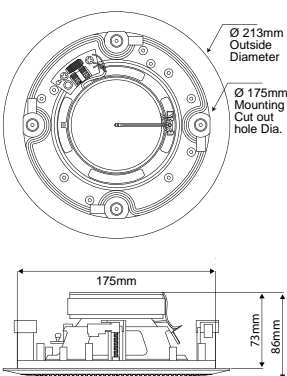

6 1/2" ADS2660

KEVLAR & TITANIUM

High performance Audiophile grade. 2-Way coaxial w/ PTC overdrive protected titanium coated tweeter. Kevlar Mid-Woofer. Spring terminals.

Code	ADS2660
Size	6.5"
Input	8Ω
Pmax	120W
Prms	60W
Freq.	60Hz-20KHz
Sens.	89dB
Packaging	Pair

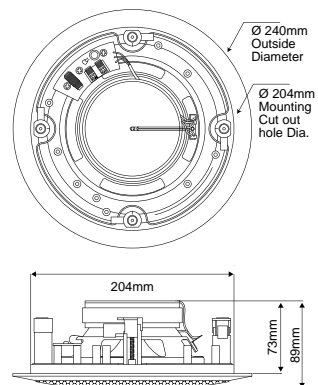

8" ADS2880

KEVLAR & TITANIUM

High performance Audiophile grade. 2-Way coaxial w/ PTC overdrive protected titanium coated tweeter. Kevlar Mid-Woofer. Spring terminals.

Code	ADS2880
Size	8"
Input	8Ω
Pmax	160W
Prms	80W
Freq.	50Hz-20KHz
Sens.	92dB
Packaging	Pair

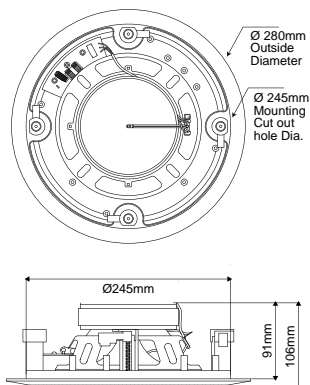

6 1/2" ADS3660

KEVLAR & TITANIUM

Sealed back box Audiophile grade. Coaxial 2-Way PTC Overdrive protected titanium coated tweeter. Kevlar Mid-Woofer. Spring terminals.

Code	ADS3660
Size	6.5"
Input	8Ω
Pmax	120W
Prms	60W
Freq.	45Hz-20KHz
Sens.	87dB
Packaging	Pair

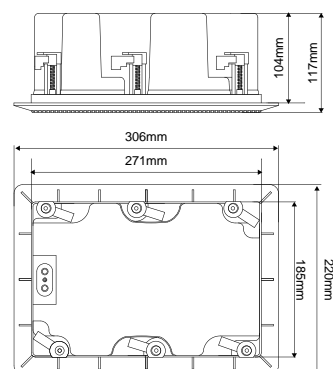

8Ω / 100V-LINE PREMIUM KEVLAR CEILING SPEAKER SEALED ENCLOSURE

ENCLOSED CABINET / SEISMIC CABLE

Sealed cabinet design protects speaker back, no dirt, no dust and no vermin. Gives better bass and reduce cavity vibration with Attachment point for seismic cable (safety cable).

SAFETY PLASTIC

Constructed from Fire retardant plastics to UL-8540T.

TILT COAXIAL TWEETER

High quality Titanium tweeter for beautiful sound and high end response. Tweeter can be tilted to give directionality to sound and an attenuator switch for softening presence and flawless sound.

HI-END WOOFER CONSTRUCTION

Cone construction is made from woven Kevlar material designed for premium sound quality audio & warm bass. Mounted in an anodised metal basket with butyl rubber surround for long exertion high SPL efficiency, low resonance and long life durability.

CROSS-OVER NETWORK

Engineered using high quality components designed to perfectly match the tweeter and woofer for exceptional sound reproduction.



SOLD IN SINGLES

SERIES MODELS



5 1/4" ADS1550

KEVLAR & TITANIUM

High performance Audiophile grade. 2-Way coaxial with PTC Overdrive protected titanium coated tweeter. 5 1/4" Kevlar Mid-Woofer. High Power, Long life and Hi-Fidelity. Input Options: 8 Ohm & 100V 6W / 3W / 1.5W Taps.

Code	ADS1550
Size	5.25"
Input	8Ω / 100V Taps 6W / 3W / 1.5W
Pmax	100W
Prms	50W
Freq.	70Hz-20Khz
Sens.	88dB
Packaging	Single

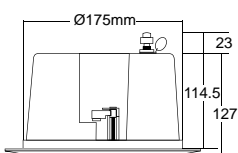
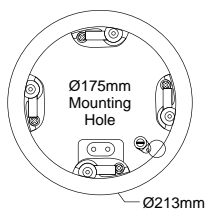

6 1/2" ADS1660

KEVLAR & TITANIUM

High Performance. PTC Protected titanium tweeter with adjustable tilt. Kevlar 6 1/2" Woofer Aluminium voice coil. High Power, Long life and Hi-Fidelity. Input Options: 8 Ohm & 100V 30W / 15W / 7.5W Taps.

Code	ADS1660
Size	6.5"
Input	8Ω / 100V Taps 30W / 15W / 7.5W
Pmax	120W
Prms	60W
Freq.	66Hz-20Khz
Sens.	88dB
Packaging	Single

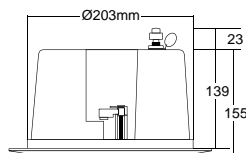
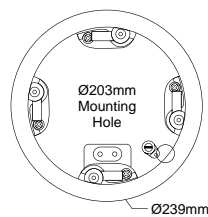

8" ADS1880

POLYPROPYLENE

High Performance. PTC Protected titanium tweeter with adjustable tilt. Kevlar 8" Woofer with aluminium voice coil. High Power, Long life and Hi-Fidelity. Input Options: 8 Ohm & 100V 50W / 25W / 12.5W Taps.

Code	ADS1880
Size	8"
Input	8Ω / 100V Taps 50W / 25W / 12.5W
Pmax	160W
Prms	80W
Freq.	50Hz-20KHz
Sens.	90dB
Packaging	Single

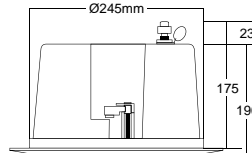

8" LOW PROFILE ADS1850

KEVLAR & TITANIUM

Suitable Small Ceiling cavity. 2-Way coaxial with Titanium Tweeter & Polypropylene 8" woofer for superior bass. Aluminium voice coil. High Power, Long life and Hi-Fidelity. Input Options: 8 Ohm & 100V 30W / 15W / 7.5W Taps.

Code	ADS1850
Size	8"
Input	8Ω / 100V Taps 30W / 15W / 7.5W
Pmax	100W
Prms	50W
Freq.	45Hz-20KHz
Sens.	88dB
Packaging	Single

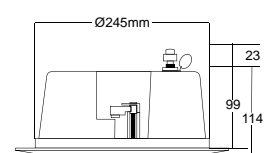
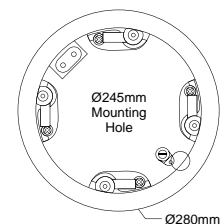

8Ω HiFi RECTANGLE CEILING / IN-WALL SPEAKERS HOME THEATRE READY

Exceptional sound reproduction delivered from the 2-Way or 3-Way speaker systems for full spectrum audio experience. Perfectly matched crossover using high quality components to maintain signal clarity and definition with adjustable tweeter brightness control on front (3-Way model only). Ideal for home theatre applications for use as front stage Left / Centre / Right using an In-Wall configuration. Also suits high end multi-room audio applications.



5 1/4" 2-WAY 8 OHM

SOLD IN PAIRS



6 1/2" 3-WAY 8 OHM

SOLD IN PAIRS

SERIES MODELS



RE-LIVE IT
HIGH FIDELITY SOUND
REPRODUCTION

5 1/4" 2-WAY 8 OHM ADS528

Modern Micro Flange Style. High End Sound reproduction via twin Mid / Woofer configuration.

25mm Dynamic Silk Dome Neodymium Tweeter with two High Performance 5 1/4" Mid-Woofer's, perfectly matched crossover using high quality components maintains signal clarity and definition.

Ideal for home theatre applications for use as front stage Left / Centre / Right using an In-Wall or In-Ceiling configuration. Suitable for high end multi-room audio applications.

Code	ADS528
Size	5.25"
Input	8Ω
Pmax	80W
Prms	40W
Freq.	62Hz-20KHz
Sens.	86dB
Packaging	Pair

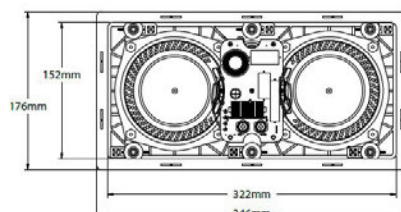
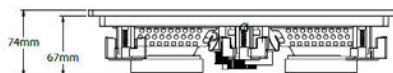

6 1/2" 3-WAY 8 OHM ADS658

Exceptional sound reproduction delivered from 3-Way System for full spectrum audio experience. Classic Flange Style.

25mm Dynamic Silk Dome Neodymium Tweeter. 1x 5 1/4" Mid-Range. 1x 6 1/2" Kevlar Woofer. Perfectly matched crossover using high quality components to maintain signal clarity and definition with adjustable tweeter brightness control on front.

High End solution for Home Theatre Left / Centre / Right front stage surround sound or in Multi-room audio. Mount In-Wall or In-Ceiling.

Code	ADS658
Size	6.5"
Input	8Ω
Pmax	160W
Prms	80W
Freq.	50Hz-20KHz
Sens.	89dB
Packaging	Pair

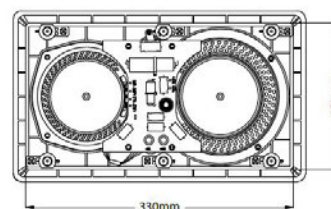
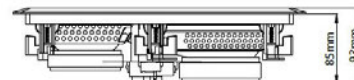

8Ω HiFi SQUARE CEILING / IN-WALL SPEAKERS

Modern Square frame Ceiling / In-Wall speaker will suit interiors where conventional round is not of choice. 8 Ohm Hi-Fi series featuring two way coaxial design, high performance Kevlar woofer, 18mm Silk Dome Tweeter matched together using a high quality cross-over with adjustable tweeter brightness. 100V PA series utilise a dual cone speaker driver. Available in multiple sizes and inputs.



SOLD IN PAIRS

SERIES MODELS



6 1/2" 2-WAY HiFi ADS680

HiFi 8 OHM Input. 2-Way Coaxial System. Kevlar Mid-Woofer with high resolution tweeter for excellent sound reproduction.

Code	ADS680
Size	6.5"
Input	8Ω
Pmax	100W
Prms	50W
Freq.	60Hz-20KHz
Sens.	88dB
Mount	Swivel Clamp 10mm
Packaging	Pair

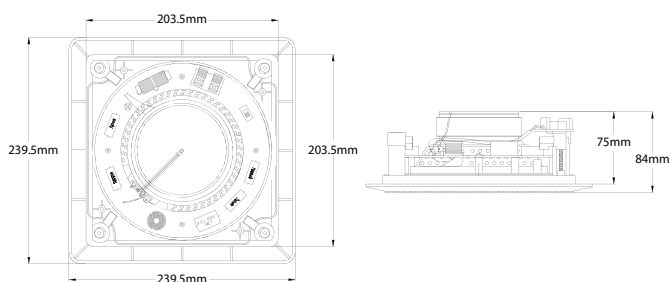

8" 2-WAY HiFi ADS860

HiFi 8 OHM Input. 2-Way Coaxial System. Kevlar Mid-Woofer with high resolution tweeter for excellent sound reproduction.

Code	ADS860
Size	8"
Input	8Ω
Pmax	120W
Prms	60W
Freq.	55Hz-20KHz
Sens.	89dB
Mount	Metal Bracket / Frame
Packaging	Pair

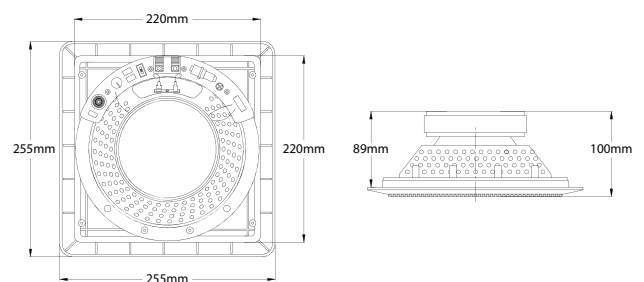

100V PA CEILING SPEAKER RAPID INSTALL SYSTEM

RAPID INSTALLATION SYSTEM !

Unique Push-To-Release spring loaded auto mounting clamps. Spiral fastener auto-fits ceiling depth 10-25mm. Use the 1/4" Allen Key (Included) for easy half-turn release of the clamp to remove the speaker. Time saving, simple, reliable and no-fuss mounting process.

2-WAY COAXIAL SYSTEM

High quality 13mm PEI dynamic tweeter for enhanced high frequency response.

APPLICATION

Suitable for most PA type applications, these drivers include a 100V Line transformer with voltage taps via bare wires for in-line type connection enabling multiple speaker setups. For 8 Ohm input, the transformer should be disconnected and the 8 Ohm input wired to the speaker directly.



SOLD IN SINGLES

SERIES MODELS

RAPID INSTALL 8 SECOND INSTALLATION

1

Insert Speaker into Installation Location

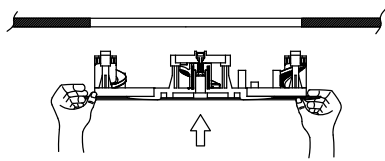

Required ceiling thickness must be between 10mm ~ 25mm

2

Use the thin side of the L shaped wrench to install the speaker. Simple push to release mounting tabs! Tabs will automatically release mount speaker to the ceiling.

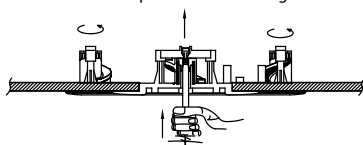

Released Tabs Lock Speaker into Ceiling



6 1/2" ADS65FT15

FAST INSTALL

Rapid Push-Release mounting system Quick & easy Install in seconds ! 25mm Aluminium High Temp voice coil Paper pulp HiFi mid-woofer speaker. Durable doped cloth roll surround Centre pole mounted coaxial tweeter 13mm dynamic PEI tweeter.

Code	ADS65FT15
Size	6.5"
Input	8Ω / 100V Taps 15W / 10W / 6W / 3W / 1.5W
Freq.	80Hz-20KHz
Pmax	30W
Prms	15W
Sens.	87dB
Packaging	Single

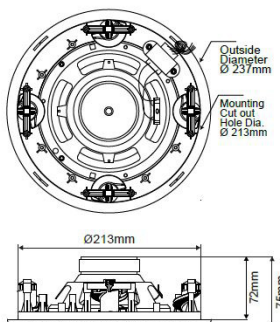

8" ADS8FT15

FAST INSTALL

Rapid Push-Release mounting system Quick & easy Install in seconds ! 25mm Aluminium High Temp voice coil Paper pulp HiFi mid-woofer speaker. Durable doped cloth roll surround centre. Pole mounted coaxial tweeter 13mm PEI dynamic tweeter.

Code	ADS8FT15
Size	8"
Input	8Ω / 100V Taps 15W / 10W / 6W / 3W / 1.5W
Freq.	62Hz-20KHz
Pmax	30W
Prms	15W
Sens.	87dB
Packaging	Single

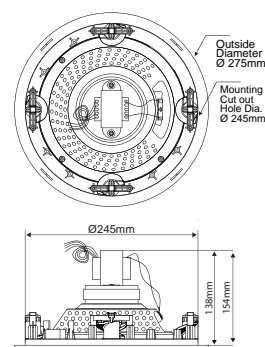

100V PA CEILING SPEAKER DUAL-CONE FULL METAL HOUSING

METAL FRAME

Excellent cost effective solution. Single piece stamped metal frame with a metal grille front fascia.

DUAL-CONE SYSTEM

Paper pulp full range speaker cone. Whizzer cone for high end response.

APPLICATION

Suitable for most PA type applications, these drivers include a 100V Line transformer with voltage taps via bare wires for in-line type connection enabling multiple speaker setups. For 8 Ohm input, the transformer should be disconnected and the 8 Ohm input wired to the speaker directly.

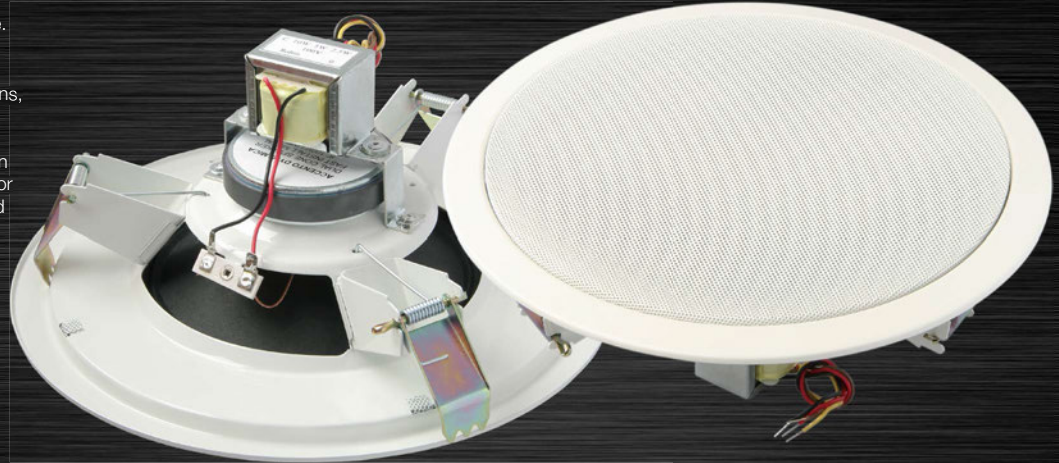

SOLD IN SINGLES

SERIES MODELS



5 1/4" ADS525FT6

METAL FRAME

Compact general purpose PA speaker. Paper pulp cone wide range with whizzer cone for high end sound. Reliable metal construction. Finger spring mount system. Built-in line transformer with 6W-3W-1.5W (8 Ohm) Taps.

Code	ADS525FT6
Size	5.25"
Input	8Ω / 100V Taps 6W / 3W / 1.5W
Freq.	186Hz-20KHz
Pmax	12W
Prms	6W
Sens.	87dB
Packaging	Single

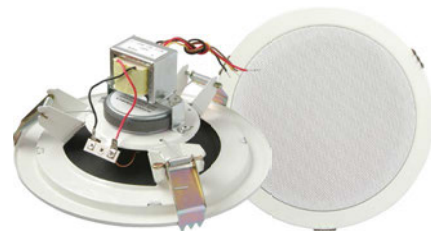
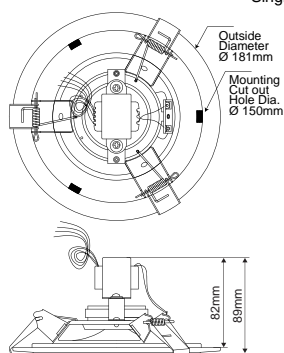

6 1/2" ADS65FT10

METAL FRAME

Compact general purpose PA speaker. Paper pulp cone wide range with whizzer cone for high end sound. Reliable metal construction. Finger spring mount system. Built-in line transformer with 10W-5W-2.5W (8 Ohm) Taps.

Code	ADS65FT10
Size	6.5"
Input	8Ω / 100V Taps 10W / 5W / 2.5W
Freq.	178Hz-20KHz
Pmax	20W
Prms	10W
Sens.	87dB
Packaging	Single

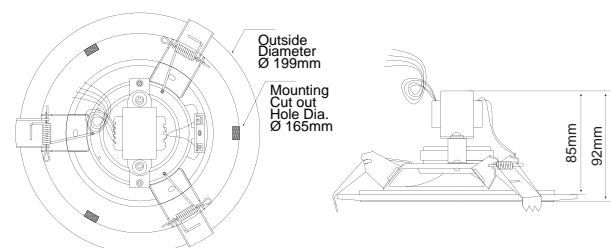

100V CEILING SPEAKER ENCLOSED METAL BOX



SOLD IN SINGLES

SERIES MODELS

METAL HOUSING. FAST INSTALL
Designed for 100V PA applications. Compact 4" ceiling speaker within an enclosed metal housing. Easy and Quick install with spring loaded tabs. Fits in $\varnothing 105\text{mm}$ mounting hole. Sold in singles.

Code	ADS400C
Input	100V Taps 6W / 3W / 1.5W
Taps	6W/3W/1.5W
Size	4"
Pmax	12W
Prms	6W
Freq.	130Hz-20KHz
Sens.	86dB
Dimensions	94x135mm \varnothing
Packaging	Single

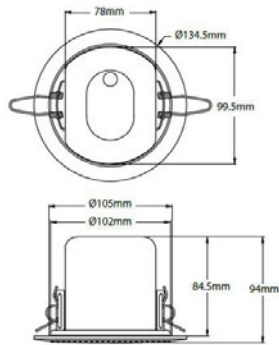

8 Ω / 100V-LINE COMPACT CUBE SPEAKER



ADS320
SOLD IN PAIRS

ADS950
SOLD IN SINGLES

HIGH PERFORMANCE COMPACT SOUND

Accento cube speakers are ultra compact with a stylish design that will fit into any decor seamlessly and provide high performance sound reproduction. Two different models available depending on input required, 8 Ohm Hi-Fi or 100V PA. Available in two colours White or Black. Includes adjustable ball joint mounting bracket to position for best audio experience and seismic cable for safety. Cube size is 87x87x112mm.

8 OHM HI-FI

Code	ADS320BK
Colour	Black
Input	8 Ω
Pmax	20W
Prms	10W
Freq.	130Hz-20KHz
Sens.	80dB
Packaging	Pair

100V PA

Code	ADS950BK
Colour	Black
Input	100V Taps 6W / 3W / 1.5W
Taps	1.5W/3W/6W
Pmax	20W
Prms	10W
Freq.	130Hz-20KHz
Sens.	80dB
Packaging	Single

REALIBILITY
DELIVERING YOUR MESSAGE
THE FIRST TIME & EVERY TIME



ACTIVE TWO-WAY SPEAKERS 5"



SOLD IN PAIRS

SERIES MODELS

ACTIVE SPEAKERS

ADJUSTABLE VOLUME,
BASS AND TREBLE.
IR REMOTE CONTROL
12V - 20V DC INPUT



CONNECT ANY AUDIO MEDIA DEVICE FOR INSTANT LOUD SOUND

High Performance, Premium Sound and Flexibility. Connect any low-level line output device to these speaker via RCA input for instant loud speaker sound. Adjustable push button Volume, Bass and Treble controls on rear or wirelessly via the included Remote Control. Powerful 5" woofer & high resolution tweeter driven by the built in amplifier module for exceptional sound reproduction and control. Manufactured using durable and high quality components. Use as bookshelf, multimedia or monitor speakers. Includes adjustable wall / ceiling mounting bracket. Includes AC/DC 20V Power Supply, Stereo 3.5mm to RCA interconnect lead and IR Remote.

Code	ADS5A40BK	ADS5A40WH
Colour	Black	White
Input	RCA	RCA
Pmax	40W	40W
Prms	20W	20W
Freq.	60Hz-20Khz	60Hz-20Khz
Sens.	85dB	85dB
Packaging	Pair	Pair

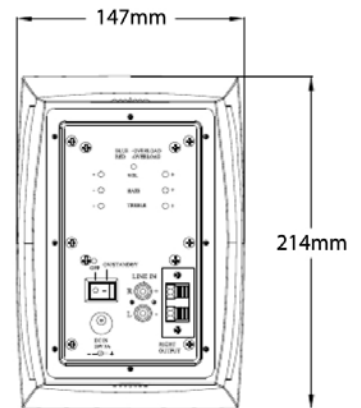
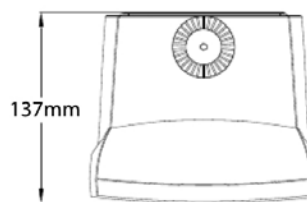

Note. Voltage input varies power output:
12V Input: 10W rms / 20W max per channel (External 12V Power Source)
20V Input: 20W rms / 40W max per channel (Included 240V Power pack)



ATMOSPHERE
INDULGE ALL SENSES
SOUND AMBIENCE FOR
ENHANCED ENJOYMENT

2-WAY INDOOR / OUTDOOR SPEAKERS WEATHER RESISTANT

2-WAY SPEAKER SYSTEM

Dynamic Mylar Tweeters (8" is silk dome). Large magnet powerful Polypropylene woofers with Butyl rubber surround in a sealed box. Flexible input options allow these speakers to be connected to 8 Ohm HiFi Audio system or 100V PA Audio System delivering outstanding quality.

INDOOR / OUTDOOR SPEAKERS

Premium Grade For Indoor / Outdoor. Superior sound reproduction high performance. Multi-purpose speakers. Ideal for outdoors under awnings / eaves, use indoor as satellite HiFi speakers and multi-room audio. High Quality Construction. Weather resistant sturdy plastic cabinet. Modern styling and attractively finished. Free-standing bookshelf or desktop. Metal wall mounting angled bracket. Quick and easy push-fit speaker wire terminals.

CONTEMPORARY

Superior sound reproduction performance. 2 Way system with Dynamic Mylar Tweeters. Large magnet powerful Polypropylene woofers. Butyl rubber surround in a sealed box. Weather resistant sturdy plastic cabinet. Colour Coated metal grilles (removable). Free-standing or mounting angled bracket.



SOLD IN PAIRS

SERIES MODELS

3½" 8Ω HiFi

Code	ADS3021W	ADS3021B
Colour	White	Black
Size	3.5"	3.5"
Input	8Ω	8Ω
Pmax	50W	50W
Prms	30W	30W
Sens.	85dB	85dB
Freq.	85Hz-20KHz	85Hz-20KHz
Packaging	Pair	Pair

3½" 100V PA / 8Ω HiFi

Code	ADS3021W-T
Colour	White
Size	3.5"
Input	8Ω / 100V Taps 20W / 10W / 5W / 2.5W
Pmax	40W
Prms	20W
Sens.	85dB
Freq.	85Hz-20KHz
Packaging	Pair

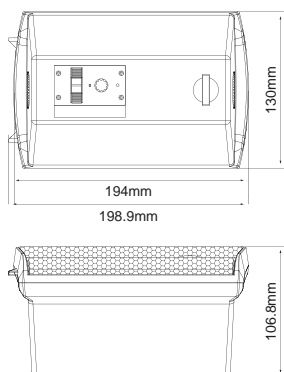

5" 8Ω HiFi

Code	ADS5021W	ADS5021B
Colour	White	Black
Size	5"	5"
Input	8Ω	8Ω
Pmax	80W	80W
Prms	50W	50W
Sens.	86dB	86dB
Freq.	80Hz-20KHz	80Hz-20KHz
Packaging	Pair	Pair

5" 100V PA / 8Ω HiFi

Code	ADS5021W-T	ADS5021B-T
Colour	White	Black
Size	5"	5"
Input	8Ω / 100V Taps 30W / 15W / 10W / 5W	8Ω / 100V Taps 30W / 15W / 10W / 5W
Pmax	60W	60W
Prms	30W	30W
Sens.	86dB	86dB
Freq.	80Hz-20KHz	80Hz-20KHz
Packaging	Pair	Pair

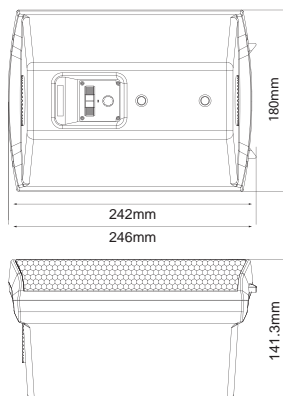

8" 8Ω HiFi

Code	ADS8021W	ADS8021B
Colour	White	Black
Size	8"	8"
Input	8Ω	8Ω
Pmax	150W	150W
Prms	80W	80W
Sens.	88dB	88dB
Freq.	75Hz-20KHz	75Hz-20KHz
Packaging	Pair	Pair

8" 100V PA / 8Ω HiFi

Code	ADS8021W-T	ADS8021B-T
Colour	White	Black
Size	8"	8"
Input	8Ω / 100V Taps 60W/30W/15W/10W	8Ω / 100V Taps 60W/30W/15W/10W
Pmax	120W	120W
Prms	60W	60W
Sens.	88dB	88dB
Freq.	75Hz-20KHz	75Hz-20KHz
Packaging	Pair	Pair

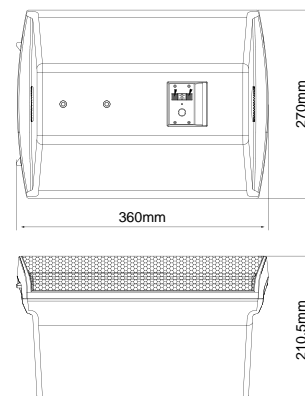

2-WAY INDOOR / OUTDOOR SPEAKERS WEATHER RESISTANT IP55 RATED

IP55 OUTDOOR SPEAKER ENCLOSURES

New fully sealed enclosure range, designed for extended life outdoors exposed to the elements & weather. Tested IP55 Waterproof rating. Attractive, quality ABS plastic. Made from UV resistant materials. Powder coated metal grille and adjustable mounting brackets. 2 Way system with mid-woofer Mica reinforced Polypropylene butyl rubber roll surround Large magnet with vented core. Mylar dome dynamic tweeter. Free-standing or wall mounted. Attractive and stylish design. Mounts vertically or horizontally

WATER-PROOF SEALED WIRING LOOM

Rear terminals remain sealed by use of a screw type plug & 1ft lead. For 100V transformer taps, simple connect to the appropriately coloured wire.

FLEXIBLE INPUT OPTIONS

Available in standard HiFi 8 Ohm for direct connection to home systems OR with in-built multi-tap 100V line transformer for PA type applications. Each tap has its own wire connection. Simply connect to a specific wire depending on application required. Available in arctic white box & grille or midnight black to suit your decor. Cabinets are modern and attractive fashion that is stylish & unobtrusive. Includes wall mounting brackets.

SOLD IN PAIRS

SERIES MODELS



5" 8Ω HiFi

Code	ADS5130B	ADS5130W
Size	5"	5"
Colour	Black	White
Input	8Ω	8Ω
Pmax	80W	80W
Prms	40W	40W
Sens.	86dB	86dB
Freq.	128Hz-20KHz	128Hz-20KHz
Packaging	Pair	Pair

5" 100V PA / 8Ω HiFi

Code	ADS5130BT	ADS5130WT
Size	5"	5"
Colour	Black	White
Input	8Ω / 100V Taps 30W / 15W / 7.5W	8Ω / 100V Taps 30W / 15W / 7.5W
Pmax	60W	60W
Prms	30W	30W
Sens.	86dB	86dB
Freq.	20KHz-128Hz	20KHz-128Hz
Packaging	Pair	Pair

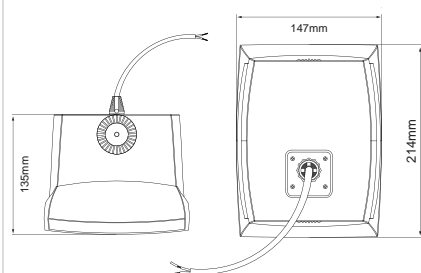

6½" 8Ω HiFi

Code	ADS6200B	ADS6200W
Size	6.5"	6.5"
Colour	Black	White
Input	8Ω	8Ω
Pmax	120W	120W
Prms	60W	60W
Sens.	87dB	87dB
Freq.	100Hz-20KHz	100Hz-20KHz
Packaging	Pair	Pair

6½" 100V PA / 8Ω HiFi

Code	ADS6200BT	ADS6200WT
Size	6.5"	6.5"
Colour	Black	White
Input	8Ω / 100V Taps 40W / 20W / 10W	8Ω / 100V Taps 40W / 20W / 10W
Pmax	80W	80W
Prms	40W	40W
Sens.	87dB	87dB
Freq.	100Hz-20KHz	100Hz-20KHz
Packaging	Pair	Pair

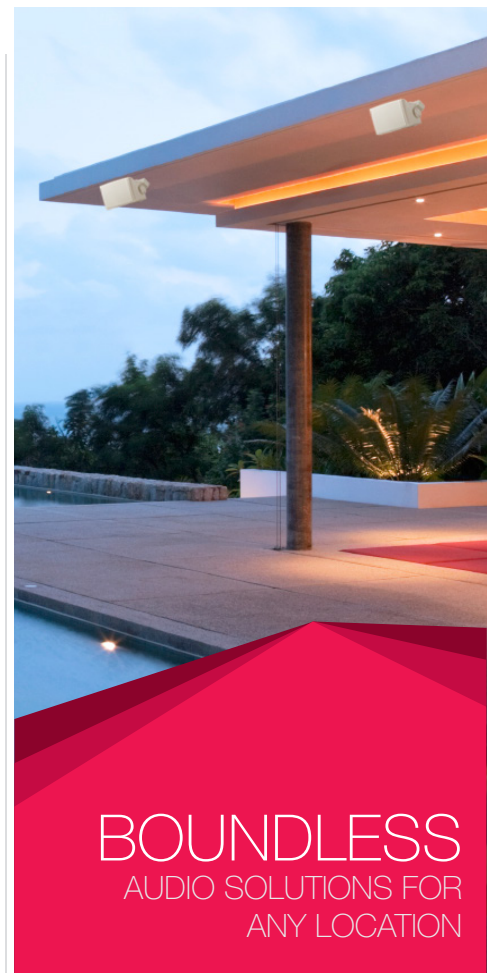
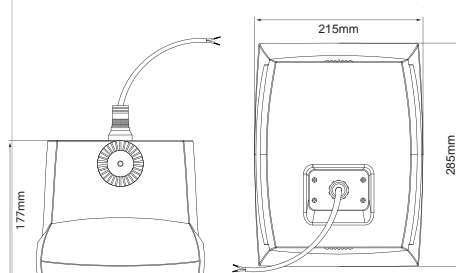

BOUNDLESS
AUDIO SOLUTIONS FOR
ANY LOCATION

ACCENTO DYNAMICA CLASS-D AMPLIFIERS

CLASS D AMPLIFIERS

These Class D amplifiers are designed to produce excellent quality in sound. They are quite compact and yet still deliver clear and vibrant audio that compares to larger high quality linear amplifiers. Ideal for home or desk-top, these amplifiers offer a modern contemporary practical function.

Three options are available in 2x15W, 2x20W and 2x30W models to suit different applications.



SOLD WITH POWER PACKS

SERIES MODELS

30W CLASS-D AMPLIFIER



- Palm-size Class-D 30 watt amplifier
- Battery option for portability (6x AA)
- Includes AC powered power supply
- 90% Amp efficiency for longer battery life
- Superior sound quality for a mini-amplifier
- Blue LED and Volume with power switch
- Soft turn-on eliminates speaker pop
- CE and RoHS rated design
- Intelligent short-circuit protection
- Intelligent over-temperature protection
- Connects to any passive 4/8Ω speakers
- 3.5mm standard audio line stereo input

Code	ADA30
Power	2x 15Wrms
Input	2x RCA
Output	4-wire signal output. Bare-wire or 4mm
Vmin	12Vdc
Freq.	20Hz - 20kHz
Noise	102dB
Weight	225g
Dimensions	150x50x90mm



40W CLASS-D AMPLIFIER



- Class D amplifier maximises fidelity and efficiency
- High performance in a compact package
- Simple operation on/off switch & volume control
- All metal black anodised extruded aluminium case
- Non slip rubber feet
- Rear RCA Stereo line-level gold-plated input
- Bare-wire or 4mm speaker connection terminals
- Includes optimum 15Vdc 2A power supply
- Highly efficient with realistic audio sound stage
- Intelligent over-temp' and short-circuit protection
- Connects to any passive 4/8Ω speakers
- Available in Bluetooth version (ADA40BT)

Code	ADA40	ADA40BT
Power	2x 20Wrms	2x 20Wrms
Input	1x RCA(L/R)	1x RCA(L/R), Bluetooth
Output	4-wire signal output. Bare-wire or 4mm	4-wire signal output. Bare-wire or 4mm
Vmin	15Vdc	15Vdc
Freq.	20Hz - 20kHz	20Hz - 20kHz
Noise	103dB	103dB
Weight	320g	320g
Dimensions	90x40x120mm	90x40x120mm



120W CLASS-D AMPLIFIER



- STA508 chipset Class-D offers Audiophile-quality sound reproduction
- Compact fits almost anywhere for modern style & minimal decor impact
- Ultra-quiet 103 dB signal to noise ratio (A-weighted)
- 40Wrms into an 8 ohm load, 60Wrms continuous into a 4 ohm load
- Front-mounted gold-plated 3.5mm input and rear gold-plated RCA inputs
- Quad mini gold-plated binding posts accept bare wire or banana plugs
- 6.35mm Headphone gold-plated output socket
- Compact extruded aluminium heat sink enclosure
- Thick, stylish black-anodized aluminium face plate
- Simple controls: Volume pot with Off position
- Short circuit, thermal, and overload protection

Code	ADA120
Power	2x 60Wrms
Input	2x RCA
Output	4-wire signal output. Bare-wire or 4mm
Vmin	24Vdc
Freq.	20Hz - 20kHz
Noise	103dB
Weight	540g
Dimensions	50x86x160mm



TUBE HYBRID AMPLIFIER 24W BLUETOOTH® - ACCENTO



accento
dynamica

**PREAMP VACUUM-TUBES**

Process the input signal and give a classic tube audio warmth to the sound

FLEXIBLE INPUT OPTIONS

Supports audio input from Bluetooth, USB and RCAx 2 inputs, and supports headphones or speaker output

SERIES MODELS

TUBE PREAMP & 12W CLASS-AB TRANSISTOR AMP WITH BLUETOOTH & USB PLAYER

The new Accento-Dynamica hybrid amplifier is a German designed HiFi mini-amp with a high quality sound for a low price that is ideal for running modern, good quality, compact speakers. Compact dimensions, fine design and of course great sound, the unit has 2 RCA inputs for tuner, CD or Media player. The Bluetooth V4.2 signal reception as well as the built-in USB audio player (supports MP3, WAV, APE, FLAC with Play/Pause/FF/REW) for modern connectivity and playback. The unit comes with 4mm speaker outputs for 4/8 ohm speakers as well as headphones 3.5mm, plus an RCA line-level output for an external active subwoofer if desired. There are two visible 6F2 tubes, which process the signal input and give a classic tube audio warmth to the sound (<0.1%THD) with Perspex finger guard, blue LED lit. The power amplifier stage is a premium Class-AB true discrete (all transistors only) design for a classic high-end analogue audio sound. The inbuilt power supply is transformer based, not switch-mode, for better low-noise audio. Built into a sleek brushed-aluminium enclosure, it has an attractive appearance to adorn your desktop or bookshelf with excellent sound quality when matched with some high-end compact speakers.

- Audiophile quality sound, German design
- True discrete transistor power amplifier
- 12Wrms x2 (25Wmax.) into a 4ohm load
- Dual 6F2 preamplifier pentode tubes
- Less than 0.1% THD @ 12W
- Transformer power supply (not SMPS)
- Rear mounted RCA type inputs x2
- Bluetooth 4.2 with external antenna
- USB Memory stick playback
- Doubles as a headphone amplifier
- RCA mono subwoofer output
- Brushed aluminium housing, metal knobs

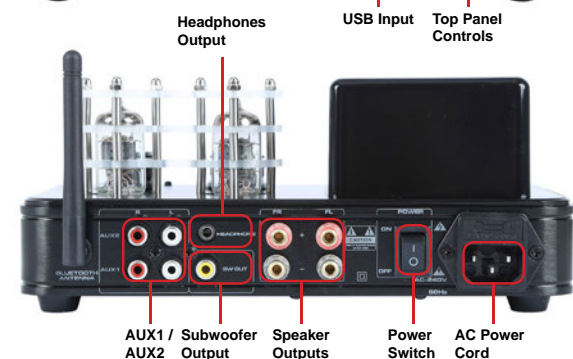

Product Code	ADHA24BT
Power Output	12Wrms x2 (4 ohms) 25Wmax x2
Total Harmonic Distortion	<0.1% @ 12W per channel
Minimum Speaker Impedance	4ohm
Frequency Response	20-20000Hz ±2dB
Channel Separation	65dB
Dynamic Range	>80dB
Signal to Noise Ratio	>80dB

Preamplifier Tube	6F2 x2
Headphone Amp Output	15mW @ 600ohms; 11mW @ 300ohms; 7.8mW @ 32ohms; 5.6mW @ 16ohms
Bluetooth Version	4.2
USB Supported File Type	Supports MP3, WAV, APE, FLAC with Play/Pause/FF/REW
Input Impedance	47k ohm (min)
Input Sensitivity	300mV
Dimensions	235x155x110mm
Weight	2kg

TUBE HYBRID AMPLIFIER 90W BLUETOOTH®



**PREAMP VACUUM-TUBES**

Process the input signal to give a classic tube audio warmth to the sound. With Bass & Treble controls.

POWER AMP TRANSISTORS

HiFi sound Class-AB output with ample power to drive any modern bookshelf or tower speaker system

FLEXIBLE INPUT OPTIONS

Supports audio input from analogue RCA (x2) Digital Coaxial or Optical DAC, Bluetooth, or USB Stick Media Player

SERIES MODELS

**4 TUBE PREAMP / 45WRMS CLASS-AB TRANSISTOR AMP
BLUETOOTH / USB / DIGITAL & ANALOGUE INPUTS**

The Accento-Dynamica hybrid amplifier is a German designed HiFi Amplifier with a high quality sound for a low price that is ideal for running modern, good quality, full sized speakers. Compact dimensions, fine design and of course great sound, the unit has 2 RCA inputs for DVD and CD, Digital inputs with Coaxial or Optical Toslink. The Bluetooth V4.2 signal reception as well as the built-in USB audio player (supports MP3, WAV, APE, FLAC with Play/Pause/FF/REW) for modern connectivity and playback. The unit comes with 4mm speaker outputs for 4/8 ohm speakers, plus an RCA line-level output for an external active subwoofer if desired. There are four visible tubes, which process the signal input and give a classic tube audio warmth to the sound (<0.1%THD) with metal chromium finger guards. The power amplifier stage is a premium Class-AB true discrete (all transistors only) design for a classic high-end analogue audio sound. The inbuilt power supply is transformer based, not switch-mode, for better low-noise audio. Built into a medium sized brushed-aluminium enclosure, it has an attractive appearance to adorn your desktop or bookshelf with excellent sound quality when matched with some high-end compact or full-sized speakers.

- Audiophile quality sound, German design
- True discrete transistor power amplifier
- 45Wrms (x2) 4Ω Class-AB transistor output
- 6U1 x2 6F2 x2 preamplifier pentode tubes
- Less than 0.1% THD @ 40Wrms (x2)
- Transformer power supply (not SMPS)
- Rear mounted RCA type inputs x2
- Digital Coax & Toslink Inputs
- Bluetooth 4.2 with internal antenna
- USB Memory stick playback
- RCA mono subwoofer output
- Brushed aluminium housing, metal knobs

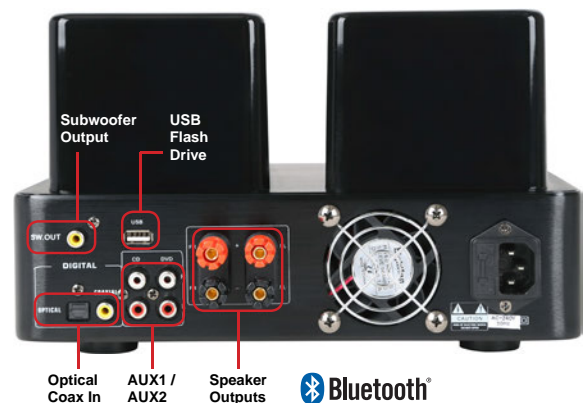

Product Code	ADHA90BT
Power Output	45Wrms x2 (4 ohms)
Total Harmonic Distortion	<0.1% @ 40W per channel
Minimum Speaker Impedance	4 ohm
Frequency Response	20-20000Hz ±2dB
Channel Separation	50dB
Dynamic Range	>80dB
Signal to Noise Ratio	>90dB

Preamplifier Tube	6U1 x2, 6F2 x2
Subwoofer Output	RCA Single Line Level Output (2Vmax) Low Pass 100Hz 12dB/Octave
Bluetooth Version	4.2
USB Supported File Type	Supports MP3, WAV, APE, FLAC with Play/Pause/FF/REW
Input Impedance	47k ohm
Input Sensitivity	250mV
Dimensions	270(d)x293(w)x167(h)mm
Weight	5kg

TUBE HYBRID AMPLIFIER 160W BLUETOOTH®

 **Bluetooth**
**PREAMP VACUUM-TUBES**

Process the input signal to give a classic tube audio warmth to the sound. With Bass & Treble controls.

POWER AMP TRANSISTORS

Premium audio quality Class-AB output with high power to drive any modern full-sized speaker system

FLEXIBLE INPUT OPTIONS

Supports audio input from analogue RCA (x2) Digital Coaxial or Optical DAC, Bluetooth V5.0, USB Stick Media Player or USB from PC.

With impressive sound quality by combining tubes with solid-state Class-AB, packaged in an attractive brushed aluminium enclosure, the ADHA160BT is a modern classic from analogue and digital inputs to the powerful 80Wrms output.

SERIES MODELS

DSP CONTROLLED DAC WITH REMOTE CONTROL
USB DAC - STREAMING FROM WIN PC

The new Accento-Dynamica hybrid amplifier is a German designed HiFi unit that uses both tubes and solid-state. The tube circuits are exclusively used in the pre-amp section to give your audio that classic tube sound that generally softens today's digital sources giving a warmer, more emotional audio experience while listening in the soft glow of the tubes. The output stage is classic Class-AB for improved speaker driving quality and accurate analogue sound. Transistors are used in the output stage because they can generate more power with less heat and reliability issues. Large, dual toroidal transformers in the power supply are used for greater performance with ample power to drive any modern speaker system. The ADHA160BT gives you the best of both worlds in sound and technology while appearing very impressive in the brushed aluminium enclosure that looks truly like classic audio with analogue VU power meters and old-school LED display. Bass and treble controls are included plus a remote control for volume, source select and control of the media player. The unit has two RCA inputs for DVD and CD plus Digital inputs with Coaxial or Optical Toslink. Built-in USB audio player (supports MP3, WAV, APE, FLAC with Play/Pause/FF/REW). The USB can also be connected to a PC for streaming audio playback. Bluetooth V5 audio input for wireless audio streaming from a phone or tablet, etc. There is also Pre-Amp output (post tubes and volume) to Main Amp Input with RCA Connections. The unit comes with 4mm / bare-wire speaker connectors for 4 to 8 ohm speakers, plus there is an RCA line-level output for an external active subwoofer if desired. With impressive sound quality, high power, digital audio connections, all in an attractive enclosure, the ADHA160BT is a modern classic.

- Tube Preamplifier with 7 Valves
- Class-AB power amp with 8x Transistors
- High output of 80Wrms (4 ohm) 2% THD
- 20Hz to 20KHz, SNR 90dB
- DSP DAC 44.1-192KHz 24 bit
- USB Input (PC) standard drivers
- USB stick MP3, WMA, FLAC player
- Coax and Toslink Optical Inputs
- Bluetooth® V5.0 up to 250m
- Two line-level stereo RCA inputs
- Bass and Treble controls
- Tube-pre out to Main amp input
- 2.1 with single RCA subwoofer out
- Temperature controlled fan
- Remote control Volume & Source
- Old school LED display
- Dual analogue VU meters
- Two heavy-duty toroidal transformers
- Brushed aluminium enclosure
- 330(d)x315(w)x165(h)mm 7.3Kg



Product Code	ADHA160BT
Power Output	80Wrms x2 (4 ohms)
Total Harmonic Distortion	<2% @ 80W per channel
Minimum Speaker Impedance	4 ohm
Frequency Response	20-20000Hz ±1dB
Channel Separation	83dB
Dynamic Range	>85dB
Signal to Noise Ratio	>90dB

Preamplifier Tube	6U1 x2, 6A2 x2, 6H2 x2, WY-3P x1
Subwoofer Output	RCA Single Line Level Output (2Vmax) Low Pass 100Hz 12dB/Octave
Bluetooth Version	5.0 (AAC, SBC)
USB Supported File Type	Supports MP3, WAV, APE, FLAC with Play/Pause/FF/REW
Input Impedance	47k ohm
Input Sensitivity	550mV
Dimensions	330(d)x315(w)x165(h)mm
Weight	7.3kg

VISUALLY BEAUTIFUL ELECTRONICALLY TRANSPARENT

HIGH END INTERCONNECT

Accento Interconnects combine European styling and functionality with premium grade audiophile technologies to create an attractive reliable and most importantly, maximum clarity and detail in the transmission between today's high performance audio-visual equipment. The extra attention to detail separates these cables from most. Hand assembled by soldering, not crimp, for a secure connection. Ultra-low-noise, Low Capacitance, Low Resistance, Low Induction, due to proven performance materials, design and construction. The beautiful elegance and style of Accento Interconnects faithfully represents audio excellence in performance to the highest standards.

AUDIO LEAD SINGLE

1 RCA Plug - 1 RCA Plug

1.5M	CXS1050
3.0M	CXS1052
5.0M	CXS1054
10M	CXS1056

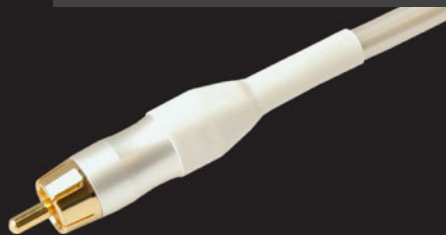

HAND CRAFTED FOR LONG-LIFE INTERCONNECT DEPENDABILITY. EUROPEAN DESIGNED HIGH-END AUDIOPHILE PERFORMANCE

- WHITE PEARL - EXCLUSIVE SERIES BY ACCENTO
- COLOUR CODED HEAT-SHRINK STRAIN RELIEF BOOTS
- PREMIUM GRADE PLUGS - HAND SOLDERED RELIABILITY
- HIGH-GLOSS PEARL FINISH - EXTRA STRONG METAL JACKET
- 24CT GOLD-PLATED CLEAN CONNECTIONS
- RCA LAM-SPRING GRIPS SURE-CONTACT PLUGS

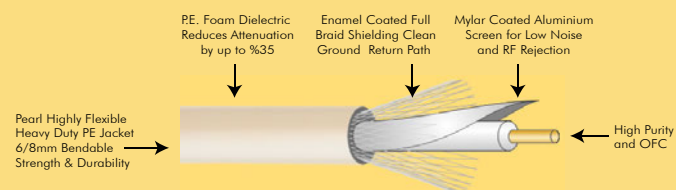

STEREO LEAD

2 RCA Plugs - 2 RCA Plugs With "Trigger Wire"

0.8M	CXS1102
1.5M	CXS1104
3.0M	CXS1106
5.0M	CXS1108
10M	CXS1110
15M	CXS1112

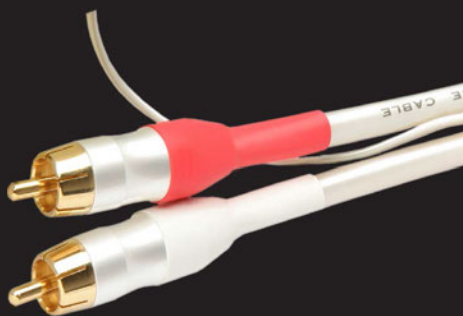

AUDIO SPLITTER LEAD 2x FEMALE TO 1x MALE

RCA Plug - 2 RCA Sockets

0.1M	CXS1020
------	---------

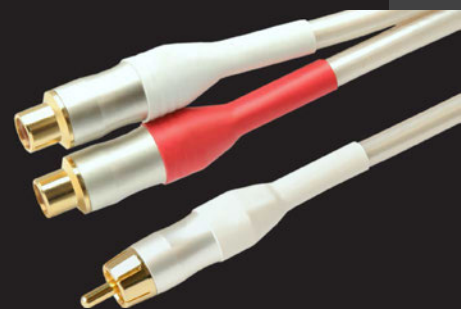

AUDIO SPLITTER LEAD

RCA Plug - 2 RCA Plugs

1.2M	CXS1060
3.0M	CXS1062
5.0M	CXS1064



AUDIO SPLITTER LEAD 2x MALE TO 1x FEMALE

RCA Socket - 2 RCA Plugs

0.1M	CXS1002
------	---------



3.5MM TO AUDIO ADAPTOR LEAD

3.5mm Headphone Plug to RCA Stereo Plugs

1.5M	CXS1450
3.0M	CXS1452
5.0M	CXS1454



DIGITAL COAXIAL VIDEO / AUDIO

1x RCA Plug - RCA Plug 75Ω 100MHz Wide-Bandwidth

0.8M	CXS1220
1.5M	CXS1222
3.0M	CXS1224
5.0M	CXS1226
10M	CXS1228

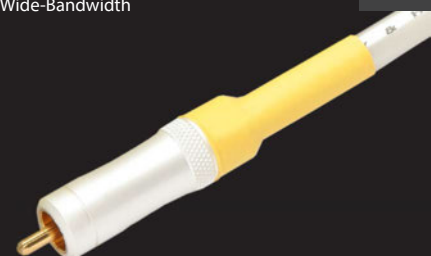

OPTICAL - TOSLINK TO TOSLINK

Toslink to Toslink Plugs

1.0M	CXS1502
2.0M	CXS1503
3.0M	CXS1504



STEREO AUDIO + COMPOSITE VIDEO

2x RCA Stereo Audio & Composite Video Plug to Plug

0.8M	CXS1150
1.5M	CXS1152
3.0M	CXS1154
5.0M	CXS1156
10M	CXS1158
15M	CXS1160

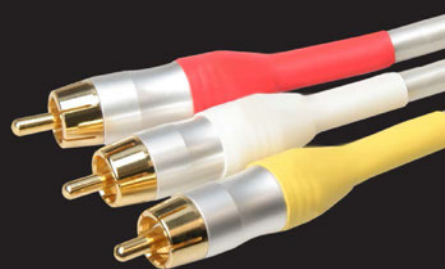

OPTICAL - TOSLINK TO 3.5MM

Toslink to 3.5mm Optical Plug

1.0M	CXS1520
3.0M	CXS1522



COMPONENT VIDEO LEAD RGB / YUV

3x RCA Plugs - 3 RCA Plugs 75Ω

0.8M	CXS1250
1.5M	CXS1252
3.0M	CXS1254
5.0M	CXS1256
10M	CXS1258
15M	CXS1260

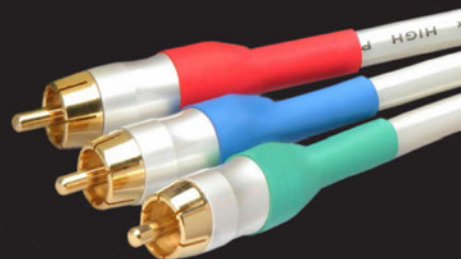

RF FLY LEAD

PAL Plug - PAL Plug 75Ω

1.0M	CXS1601
1.5M	CXS1602
3.0M	CXS1603
5.0M	CXS1605
10M	CXS1610



COMPOSITE VIDEO LEAD

1x RCA Plug - RCA Plug 75Ω

0.8M	CXS1200
1.5M	CXS1202
3.0M	CXS1204
5.0M	CXS1206
10M	CXS1208
15M	CXS1210



3.5MM TO AV ADAPTOR LEAD

3.5mm "Quad" Plug to Stereo Audio + Composite Video

1.5M	CXS1490
------	---------



SCART TO AV IN / OUT

SCART Plug to 2x Video + 4x Audio

1.5M	CXS1310
------	---------





INTERCONNECT



Distributed By:



WES AUSTRALASIA

Email: sales@wes.net.au - Web: www.wes.net.au

Phone: 02 9797 9866 - Fax: 02 9716 6015

Address: 84-90 Parramatta Road, Summer Hill, NSW 2130